

NACHI

Legato

SAW Series

*Solenoid Valve with Monitoring Switch
For Press Safety Confirming Systems*

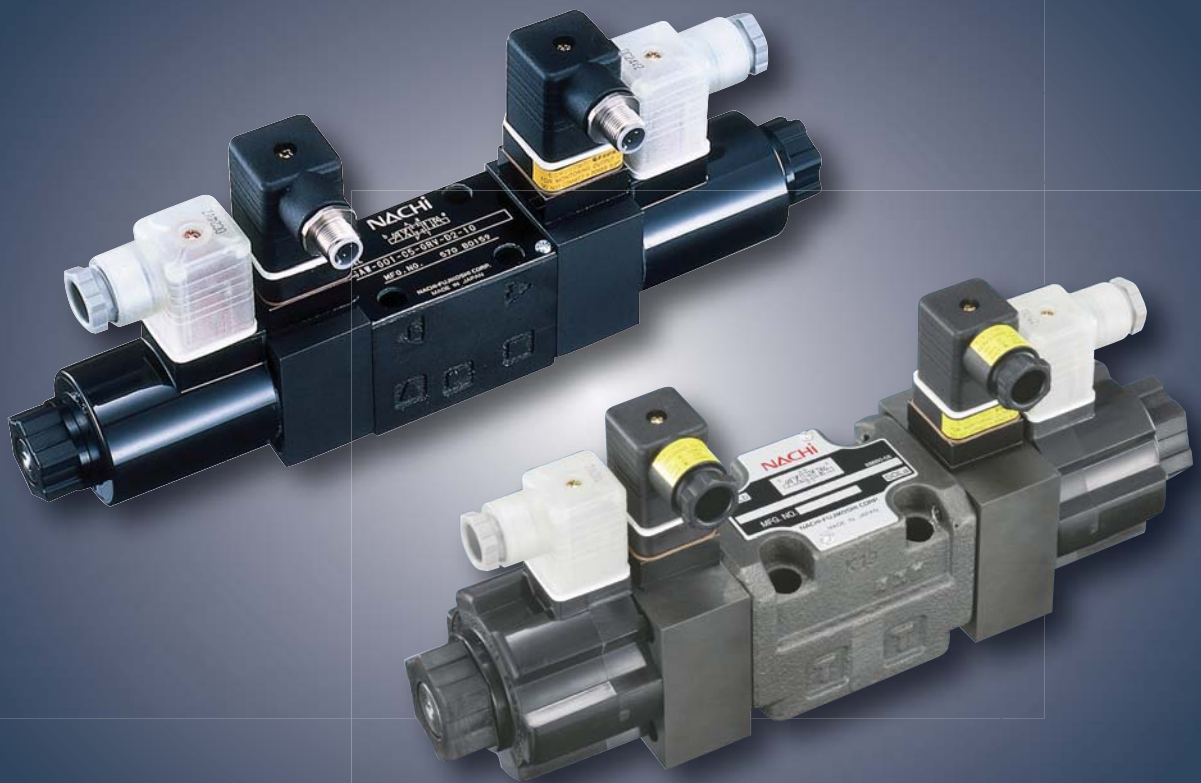

SAW Series

Solenoid Valve with Monitoring Switch For Press Safety Confirming Systems

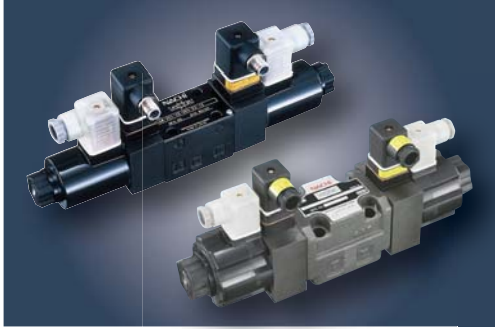

Safety is critical in the manufacturing industry. Today, most manufacturers rely on a conventional system that detects danger and stops a machine during operation. In Japan, however, the trend is to utilize a **Safety Monitoring System** to monitor safety and allow a machine to operate after safety is confirmed. As new global safety standards are established, it is predicted that these Safety Monitoring Systems will be included in machine specifications at the design stage. Our Solenoid Valve with Monitoring Switch, Japan's first Safety Monitoring System, is specially designed to meet the requirements of machine integration and safety.

ISO 12100 will change the industry's perception of mechanical hazard protection. In the future, machines will require safety standards compliant with ISO 12100

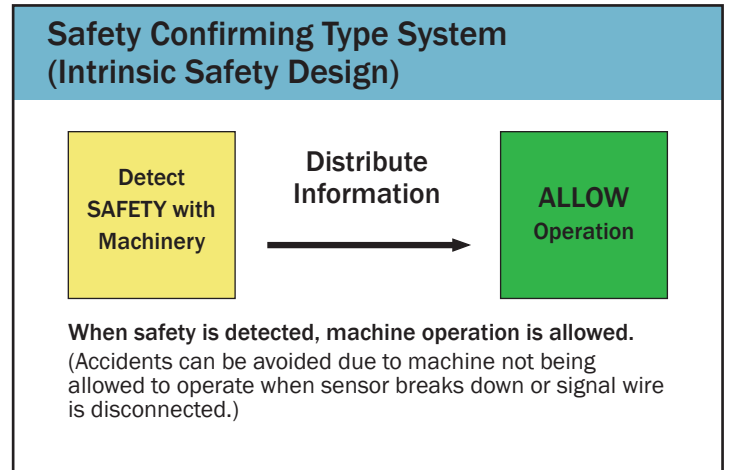
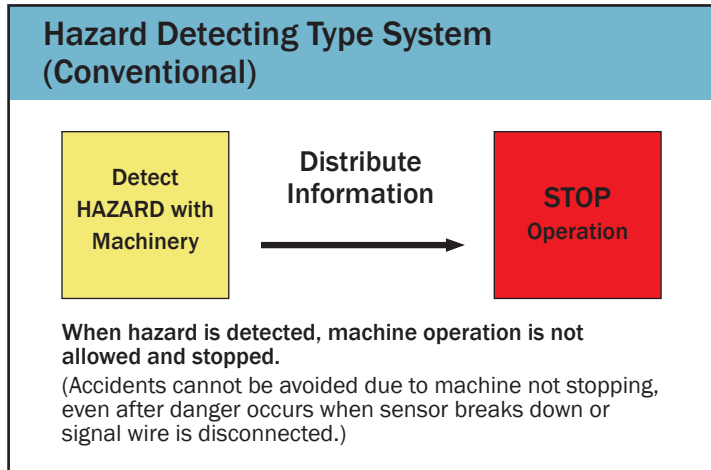

Features

This valve mechanically detects the movement of the solenoid valve spool to activate the switch and to transmit an electrical ON/OFF signal. In other words, this valve monitors a spool operating condition and can be used for sequence control according to its ON/OFF signal. It is also an information source for confirming safety conditions.

Fig. 1 and 2 show the simplified actuation structure of a solenoid valve with monitoring switch. When the spool is in center position, the fixed contact (blue) contacts the traveling contact (red) and both contacts become in conducting condition (Switch ON). When the solenoid is energized and the spool moves right, the traveling contact (red) detaches from the fixed contact (blue) in conjunction with the spool movement and both contacts become in non-conducting condition (Switch OFF).

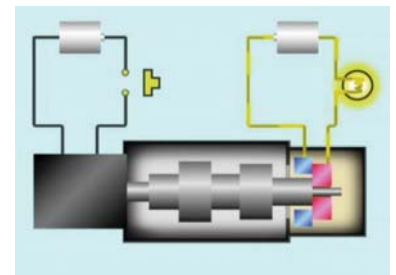

Fig. 1 Solenoid not energized (Switch ON)

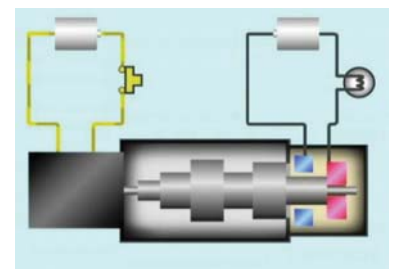
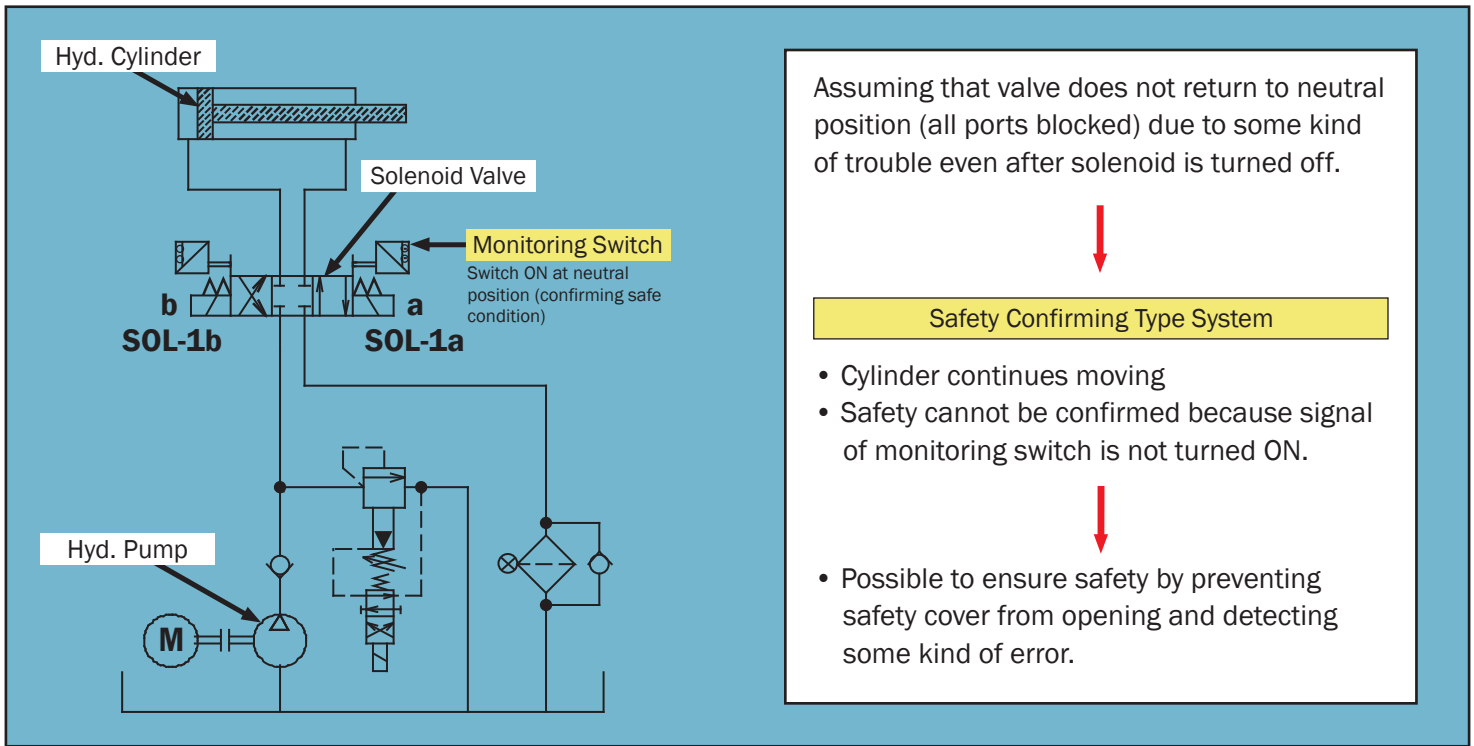

Fig. 2 Solenoid energized (Switch OFF)

Example of Use



Specifications

Series		SAW-G01	SAW-G03
Operation Type		Direct operated type spool valve	
Max. Working Pressure (Note 1)		35MPa (5,076 psi)	
Max. Flow Rate (Note 2)		100Lmin (26.4 gpm)	160Lmin (42.2 gpm)
Max. Allowable Back-Pressure		21MPa (3,046 psi)	16MPa (2,320 psi)
Operating Environment	Dust Resistance/ Water Resistance Rank	JIS C0920 IP65	
	Operating Fluid (Note 3)	Petroleum type	
	Ambient Temperature	-20° to 50° C (-4° to 122° F)	
	Temperature Range	-20° to 70° C (-4° to 158° F)	
	Viscosity Range	15 - 300 mm ² /s	
	Filtration	25μm or less	
Monitoring Switch (Note 4)	Rated Voltage	DC24V	
	Allowable Voltage Range (Note 4)	DC24V±20%	
	Max. Load Current	100mA	
	Residual Voltage (Note 5)	Max. 1.2V	
	Wiring to Connector	Lead wire or M12-4 pins connector	

(Note 1) The maximum working pressure is dependent on the valve type.

(Note 2) The maximum flow rate is dependent on the valve type and the working pressure.

(Note 3) Use petroleum type operating fluid only. The fluid requires insulation performance for configuration of the monitoring switch being operated in the fluid. Fluids other than petroleum type (e.g. water-glycol, water in oil emulsion type, phosphate ester, fatty acid ester) are not acceptable. Even petroleum type must not exceed 0.1% of water content.

(Note 4) Plus (+) common method and minus (-) common method are available for programmable controller input circuit. Solenoid valve with monitoring switch employs source method (switch on at load and plus (+) side of the power supply) for safety of electric circuit. Consequently, when inputting a monitoring switch output into a programmable controller, use a minus (-) common type programmable controller.

(Note 5) Supply voltage to the monitoring switch shall be given within a range fulfilling the following condition. Load ON voltage + Residual voltage. Switch supply voltage 28.8 V (Rate voltage + 20%)

Dimensional Drawings

SAW-G01 Series

The installation dimension on the gasket surface is the same as ISO 4401-03-02.

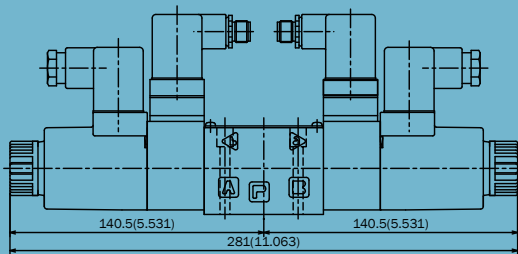
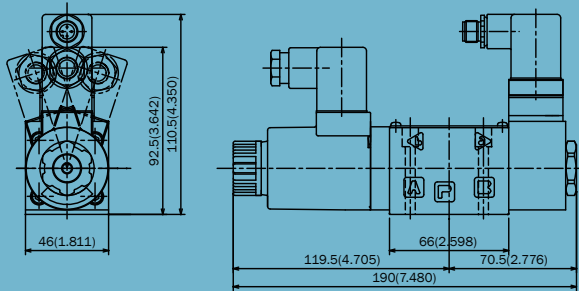
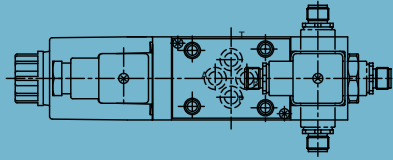

SAW-G03 Series

The installation dimension on the gasket surface is the same as ISO 4401-05-04.

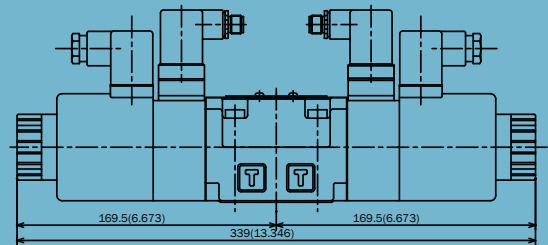
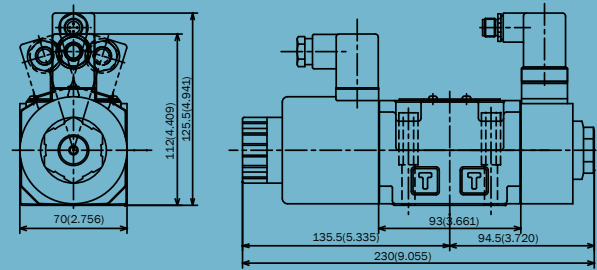
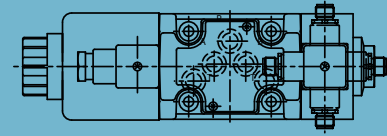

(Note 1) Dimension is for DC solenoid.

(Note 2) The connector for switch in the above is with M12-4 pin connector. Also available with lead wire.

(Note 3) The connector wiring port should be pointed in the direction shown in the above on the ground of packing when shipping. Change the direction as needed when wiring.

NACHI

NACHI AMERICA INC.

715 Pushville Rd., Greenwood, IN 46143

Tel (800) 622-4410 Fax (317) 530-1015

Email: hydraulics@nachi-america.com

www.nachi-america.com